

## OIKO PRO ADJUSTABLE RECESSED

### A35842-

base number	Color Temperature	Finishes (Diamond)	Finishes (Triangle)	Lens Options
-------------	----------------------	-----------------------	------------------------	-----------------

- To build a product code in our configurator select the specify button on the base model # product page
- To build a manual product code on this datasheet choose from the options listed below in blue font and add the suffix to the base model #

#### GENERAL

Series: Oiko Pro  
 Subseries: Oiko Pro Adjustable  
 Brand: Prolicht  
 Division: Architectural  
 Mounting Type: Recessed  
 Mounting Location: Ceiling  
 Subcategory: Downlight

#### PHYSICAL

Shape: Round  
 Diameter (mm): 75  
 Diameter (in): 2 <sup>15</sup>/<sub>16</sub>  
 Height (mm): 116  
 Height (in): 4 <sup>9</sup>/<sub>16</sub>  
 Ceiling Thickness (mm): 1 - 25  
 Ceiling Thickness (in): 1/16 - 1 3/16  
 Min. Recessing Depth (mm): 125  
 Min. Recessing Depth (in): 4 <sup>15</sup>/<sub>16</sub>  
 Light Distribution: Direct  
 Weight (kg): 0.29  
 Fixture Finish: SSR / BKV / CWI / CRY / HAB / UFT / ITA / RUA / FTG / MYG / LOD / PUS / FRO / FUP / KIA / POP / BLS / SPG / MEY / GOH / GUM / CHC / COM / ABZ / JAG / OBR / MOS / ROR  
 Fixture Material: Aluminum Die Cast  
 Cut-out Measurements: D. 68mm / 2 2/3"

#### ELECTRICAL

Lamp Type: LED (Zhaga Standard)  
 Input Wattage (W): 15  
 Total Output Wattage (W): 13.6  
 Dimming: Tri-Mode (Non-Dimming and Phase Dimming (120Vac only) and 0-10V Dimming)  
 Driver Included: No  
 Driver Location: Recessed Housing  
 Driver Type: Constant Current - Universal  
 Driver Class: Class 2  
 Input Voltage (V): 120 - 277  
 Constant Current (MA): 350

#### LED

Number of LEDs: 1  
 Color Temperature (°K): 2700 / 3000 / 3500 / 4000  
 Max. Delivered Lumen (lm): 1295 / 1377 / 1442 / 1455  
 Nominal Lumen (lm): 1566 / 1665 / 1743 / 1759  
 CRI: >90 CRI  
 Lamp Life (hrs): 50000

#### OPTICAL

Reflector°: 34  
 Adjustability: Rotational 350° / Tilt 25°

#### RATINGS AND CERTIFICATIONS

Certified By: Certified for North American Standards  
 IP rating: IP20

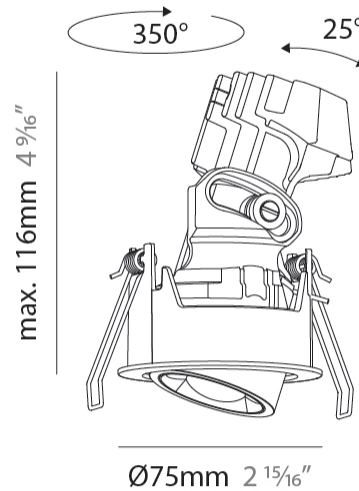

## OIKO PRO ADJUSTABLE RECESSED

A35842-

PROJECT

TYPE

SPECIFIER

QUANTITY

DATE



A

## OIKO PRO ADJUSTABLE RECESSED

### A35843-

base number    Color    Finishes    Finishes    Lens  
 Temperature    (Diamond)    (Triangle)    Options

- To build a product code in our configurator select the specify button on the base model # product page
- To build a manual product code on this datasheet choose from the options listed below in blue font and add the suffix to the base model #

#### GENERAL

Series: Oiko Pro  
 Subseries: Oiko Pro Adjustable  
 Brand: Prolicht  
 Division: Architectural  
 Mounting Type: Recessed  
 Mounting Location: Ceiling  
 Subcategory: Downlight

#### PHYSICAL

Shape: Round  
 Diameter (mm): 75  
 Diameter (in): 2 <sup>15</sup>/<sub>16</sub>  
 Height (mm): 103  
 Height (in): 4 <sup>1</sup>/<sub>16</sub>  
 Ceiling Thickness (mm): 10 / 12.5 / 15 / 25  
 Ceiling Thickness (in): 3/8 or 1/2 or 9/16 or 1  
 Min. Recessing Depth (mm): 115  
 Min. Recessing Depth (in): 4 <sup>1</sup>/<sub>2</sub>  
 Light Distribution: Downlight  
 Diffuser: Lens Pack - Spread Lens / Linear Spread Lens / Honeycomb Louver  
 Fixture Finish: SSR / BKV / CWI / CRY / HAB / UFT / ITA / RUA / FTG / MYG / LOD / PUS / FRO / FUP / KIA / POP / BLS / SPG / MEY / GOH / GUM / CHC / COM / ABZ / JAG / OBR / MOS / ROR  
 Fixture Material: Aluminum Die Cast  
 Cut-out Measurements: D. - 68mm / 2 11/16"

#### ELECTRICAL

Lamp Type: LED (Zhaga Standard)  
 Input Wattage (W): 15  
 Total Output Wattage (W): 13.6  
 Dimming: Tri-Mode (Non-Dimming and Phase Dimming (120Vac only) and 0-10V Dimming)  
 Driver Included: No  
 Driver Location: Recessed Housing  
 Driver Type: Constant Current - Universal  
 Driver Class: Class 2  
 Input Voltage (V): 120 - 277  
 Constant Current (MA): 350

#### LED

Number of LEDs: 1  
 Color Temperature (°K): 2700 / 3000 / 3500 / 4000  
 Max. Delivered Lumen (lm): 1375 / 1462 / 1531 / 1545  
 Nominal Lumen (lm): 1566 / 1665 / 1743 / 1759  
 CRI: >90 CRI  
 Lamp Life (hrs): 50000

#### OPTICAL

Reflector: 50

#### RATINGS AND CERTIFICATIONS

Certified By: Certified for North American Standards  
 IP rating: IP20

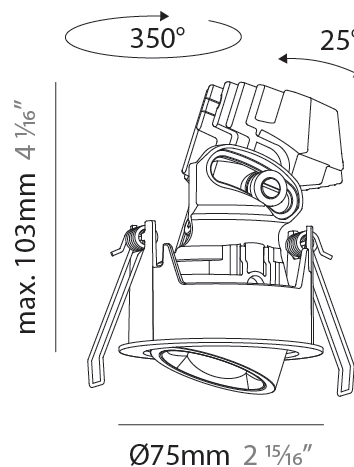

## OIKO PRO ADJUSTABLE RECESSED

A35843-

PROJECT \_\_\_\_\_

TYPE \_\_\_\_\_

SPECIFIER \_\_\_\_\_

QUANTITY \_\_\_\_\_

DATE \_\_\_\_\_

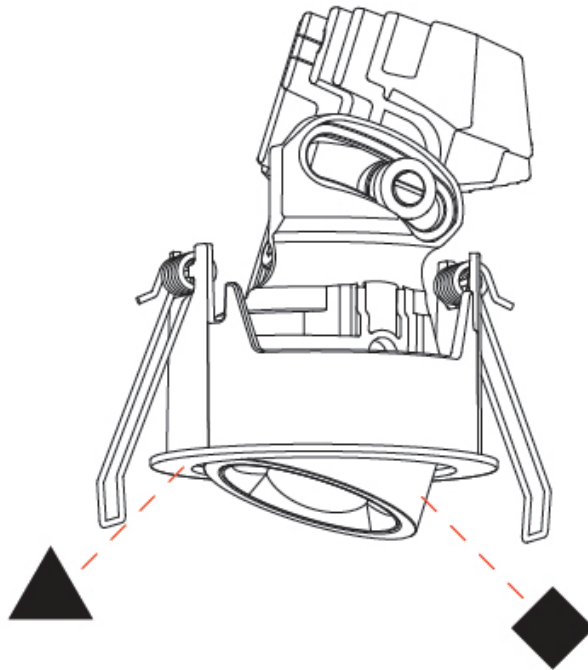

A

PROJECT	
TYPE	
SPECIFIER	
QUANTITY	
DATE	

## OIKO PRO ROUND RECESSED

### A35867-

base number	Color	Finishes	Lens
	Temperature	(Diamond)	Options

- To build a product code in our configurator select the specify button on the base model # product page
- To build a manual product code on this datasheet choose from the options listed below in blue font and add the suffix to the base model #

#### GENERAL

Series: Oiko Pro
Subseries: Oiko Pro Round
Brand: Prolicht
Division: Architectural
Mounting Type: Recessed
Mounting Location: Ceiling
Subcategory: Downlight

#### PHYSICAL

Shape: Round
Diameter (mm): 75
Diameter (in): 2 15/16
Height (mm): 65
Height (in): 2 9/16
Ceiling Thickness (mm): 1 - 25
Ceiling Thickness (in): 1/16 - 1 3/16
Min. Recessing Depth (mm): 70
Min. Recessing Depth (in): 2 3/4
Light Distribution: Direct
Diffuser: Lens Pack - Spread Lens / Linear Spread Lens / Honeycomb Louver
Fixture Finish: SSR / BKV / CWI / CRY / HAB / UFT / ITA / RUA / FTG / MYG / LOD / PUS / FRO / FUP / KIA / POP / BLS / SPG / MEY / GOH / GUM / CHC / COM / ABZ / JAG / OBR / MOS / ROR
Fixture Material: Aluminum Die Cast
Cut-out Measurements: 68mm / 2 11/16" Diameter

#### ELECTRICAL

Lamp Type: LED (Zhaga Standard)
Input Wattage (W): 15
Total Output Wattage (W): 13.6
Dimming: Tri-Mode (Non-Dimming and Phase Dimming (120Vac only) and 0-10V Dimming)
Driver Included: No
Driver Location: Recessed Housing
Driver Type: Constant Current - Universal
Driver Class: Class 2
Housing: See Components
Input Voltage (V): 120 - 277
Constant Current (MA): 350

#### LED

Color Temperature (°K): 2700 / 3000 / 3500 / 4000
Max. Delivered Lumen (lm): 1295 / 1377 / 1442 / 1455
Nominal Lumen (lm): 1566 / 1665 / 1743 / 1759
CRI: >90 CRI
Lamp Life (hrs): 50000

#### OPTICAL

Reflector: 34
Adjustability: Fixed

#### RATINGS AND CERTIFICATIONS

Certified By: Certified for North American Standards
IP rating: IP20

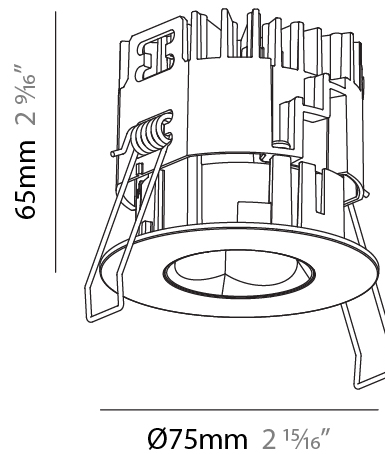

## OIKO PRO ROUND RECESSED

A35867-

PROJECT

TYPE

SPECIFIER

QUANTITY

DATE

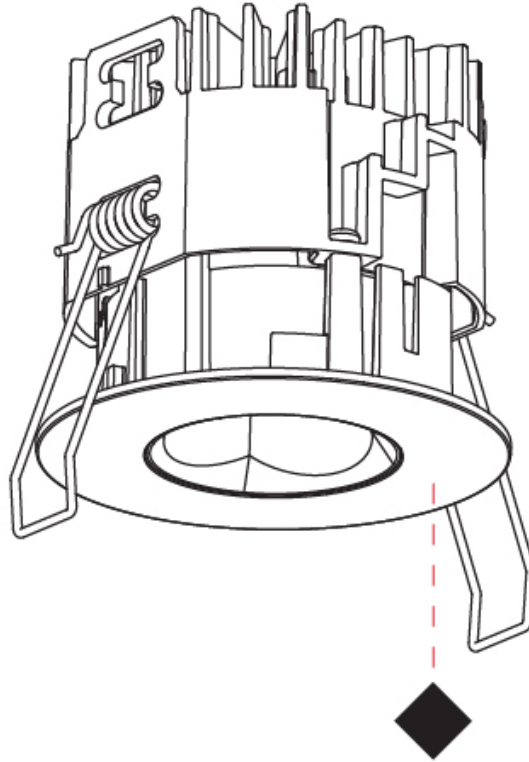

PROJECT	_____
TYPE	_____
SPECIFIER	_____
QUANTITY	_____
DATE	_____

## OIKO PRO ROUND RECESSED

### A35868-

base number	Color	Finishes	Lens
	Temperature	(Diamond)	Options

- To build a product code in our configurator select the specify button on the base model # product page
- To build a manual product code on this datasheet choose from the options listed below in blue font and add the suffix to the base model #

#### GENERAL

Series: Oiko Pro  
 Subseries: Oiko Pro Round  
 Brand: Prolicht  
 Division: Architectural  
 Mounting Type: Recessed  
 Mounting Location: Ceiling  
 Subcategory: Downlight

#### PHYSICAL

Shape: Round  
 Diameter (mm): 75  
 Diameter (in): 2 <sup>15</sup>/<sub>16</sub>  
 Height (mm): 51  
 Height (in): 2  
 Ceiling Thickness (mm): 1 - 25  
 Ceiling Thickness (in): 1/16 - 1 3/16  
 Min. Recessing Depth (mm): 55  
 Min. Recessing Depth (in): 2 <sup>3</sup>/<sub>16</sub>  
 Light Distribution: Direct  
 Diffuser: Lens Pack - Spread Lens / Linear Spread Lens / Honeycomb Louver  
 Fixture Finish: SSR / BKV / CWI / CRY / HAB / UFT / ITA / RUA / FTG / MYG / LOD / PUS / FRO / FUP / KIA / POP / BLS / SPG / MEY / GOH / GUM / CHC / COM / ABZ / JAG / OBR / MOS / ROR  
 Fixture Material: Aluminum Die Cast  
 Cut-out Measurements: 68mm / 2 11/16" Diameter

#### ELECTRICAL

Lamp Type: LED (Zhaga Standard)  
 Input Wattage (W): 15  
 Total Output Wattage (W): 13.6  
 Dimming: Tri-Mode (Non-Dimming and Phase Dimming (120Vac only) and 0-10V Dimming)  
 Driver Included: No  
 Driver Location: Recessed Housing  
 Driver Type: Constant Current - Universal  
 Driver Class: Class 2  
 Input Voltage (V): 120 - 277  
 Constant Current (MA): 350

#### LED

Color Temperature (°K): 2700 / 3000 / 3500 / 4000  
 Max. Delivered Lumen (lm): 1375 / 1462 / 1531 / 1545  
 Nominal Lumen (lm): 1566 / 1665 / 1743 / 1759  
 CRI: >90 CRI  
 Lamp Life (hrs): 50000  
 Special LEDs offerings: Tunable White

#### OPTICAL

Reflector°: 50  
 Adjustability: Fixed

#### RATINGS AND CERTIFICATIONS

Certified By: Certified for North American Standards  
 IP rating: IP20

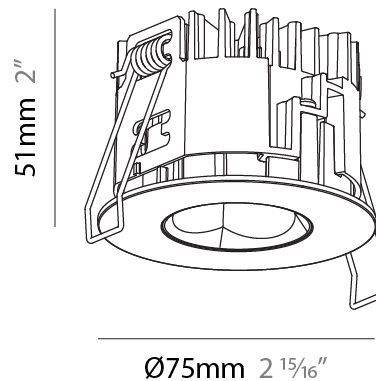

## OIKO PRO ROUND RECESSED

A35868-

PROJECT

TYPE

SPECIFIER

QUANTITY

DATE

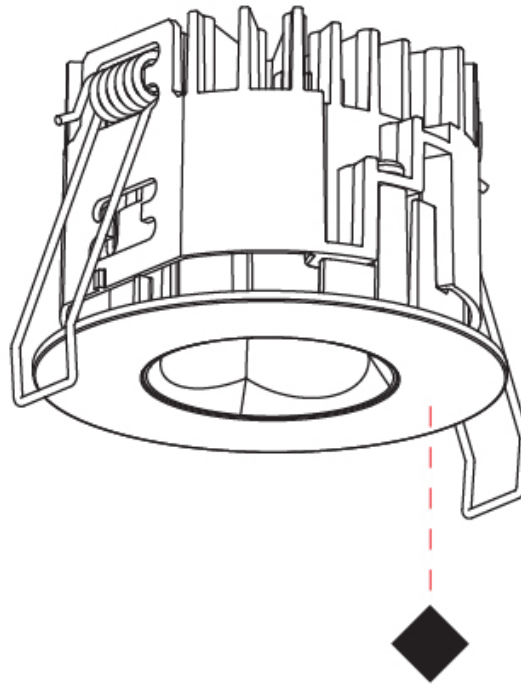



PROJECT	_____
TYPE	_____
SPECIFIER	_____
QUANTITY	_____
DATE	_____

## OIKO PRO ROUND RECESSED

### A35869-

base number	Color	Finishes	Lens
	Temperature	(Diamond)	Options

- To build a product code in our configurator select the specify button on the base model # product page
- To build a manual product code on this datasheet choose from the options listed below in blue font and add the suffix to the base model #

#### GENERAL

Series: Oiko Pro
Subseries: Oiko Pro Round
Brand: Prolicht
Division: Architectural
Mounting Type: Recessed
Mounting Location: Ceiling
Subcategory: Downlight

#### PHYSICAL

Shape: Round
Diameter (mm): 75
Diameter (in): 2 15/16
Height (mm): 43
Height (in): 1 11/16
Ceiling Thickness (mm): 1 - 25
Ceiling Thickness (in): 1/16 - 1 3/16
Min. Recessing Depth (mm): 50
Min. Recessing Depth (in): 1 15/16
Light Distribution: Direct
Diffuser: Lens Pack - Spread Lens / Linear Spread Lens / Honeycomb Louver
Fixture Finish: SSR / BKV / CWI / CRY / HAB / UFT / ITA / RUA / FTG / MYG / LOD / PUS / FRO / FUP / KIA / POP / BLS / SPG / MEY / GOH / GUM / CHC / COM / ABZ / JAG / OBR / MOS / ROR
Fixture Material: Aluminum Die Cast
Cut-out Measurements: 68mm / 2 11/16" Diameter

#### ELECTRICAL

Lamp Type: LED (Zhaga Standard)
Input Wattage (W): 15
Total Output Wattage (W): 13.6
Dimming: Tri-Mode (Non-Dimming and Phase Dimming (120Vac only) and 0-10V Dimming)
Driver Included: No
Driver Location: Recessed Housing
Driver Type: Constant Current - Universal
Driver Class: Class 2
Input Voltage (V): 120 - 277
Constant Current (MA): 350

#### LED

Color Temperature (°K): 2700 / 3000 / 3500 / 4000
Max. Delivered Lumen (lm): 1464 / 1556 / 1630 / 1645
Nominal Lumen (lm): 1566 / 1665 / 1743 / 1759
CRI: >90 CRI
Lamp Life (hrs): 50000

#### OPTICAL

Reflector°: 60
Adjustability: Fixed

#### RATINGS AND CERTIFICATIONS

Certified By: Certified for North American Standards
IP rating: IP20

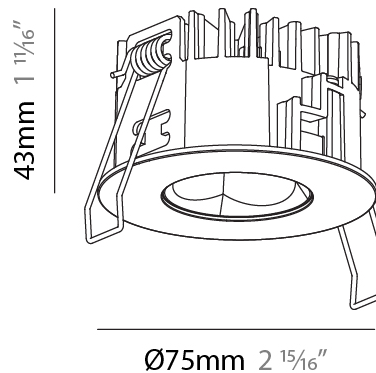

## OIKO PRO ROUND RECESSED

A35869-

PROJECT

TYPE

SPECIFIER

QUANTITY

DATE

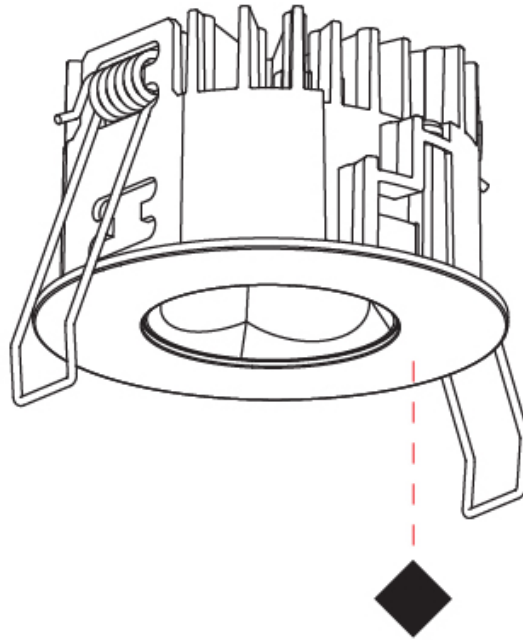

## OIKO PRO ROUND TRIMLESS

### A35878-

base number    Color    Finishes    Lens  
 Temperature    (Diamond)    Options

- To build a product code in our configurator select the specify button on the base model # product page
- To build a manual product code on this datasheet choose from the options listed below in blue font and add the suffix to the base model #

#### GENERAL

Series: Oiko Pro  
 Subseries: Oiko Pro Round  
 Brand: Prolicht  
 Division: Architectural  
 Mounting Type: Trimless  
 Mounting Location: Ceiling  
 Subcategory: Downlight

#### PHYSICAL

Shape: Round  
 Diameter (mm): 75  
 Diameter (in): 2 15/16  
 Height (mm): 65  
 Height (in): 2 9/16  
 Ceiling Thickness (mm): 10 / 12.5 / 15 / 25  
 Ceiling Thickness (in): 3/8 or 1/2 or 9/16 or 1  
 Min. Recessing Depth (mm): 70  
 Min. Recessing Depth (in): 2 3/4  
 Light Distribution: Direct  
 Diffuser: Lens Pack - Spread Lens / Linear Spread Lens / Honeycomb Louver  
 Fixture Finish: SSR / BKV / CWI / CRY / HAB / UFT / ITA / RUA / FTG / MYG / LOD / PUS / FRO / FUP / KIA / POP / BLS / SPG / MEY / GOH / GUM / CHC / COM / ABZ / JAG / OBR / MOS / ROR  
 Fixture Material: Aluminum Die Cast  
 Cut-out Measurements: 68mm / 2 11/16" Diameter

#### ELECTRICAL

Lamp Type: LED (Zhaga Standard)  
 Input Wattage (W): 15  
 Total Output Wattage (W): 13.6  
 Dimming: Tri-Mode (Non-Dimming and Phase Dimming (120Vac only) and 0-10V Dimming)  
 Driver Included: No  
 Driver Location: Recessed Housing  
 Driver Type: Constant Current - Universal  
 Driver Class: Class 2  
 Input Voltage (V): 120 - 277  
 Constant Current (MA): 350

#### LED

Color Temperature (°K): 2700 / 3000 / 3500 / 4000  
 Max. Delivered Lumen (lm): 1295 / 1377 / 1442 / 1455  
 Nominal Lumen (lm): 1566 / 1665 / 1743 / 1759  
 CRI: >90 CRI  
 Lamp Life (hrs): 50000

#### OPTICAL

Reflector°: 34  
 Adjustability: Fixed

#### RATINGS AND CERTIFICATIONS

Certified By: Certified for North American Standards  
 IP rating: IP20



## OIKO PRO ROUND TRIMLESS

A35878-

PROJECT

TYPE

SPECIFIER

QUANTITY

DATE

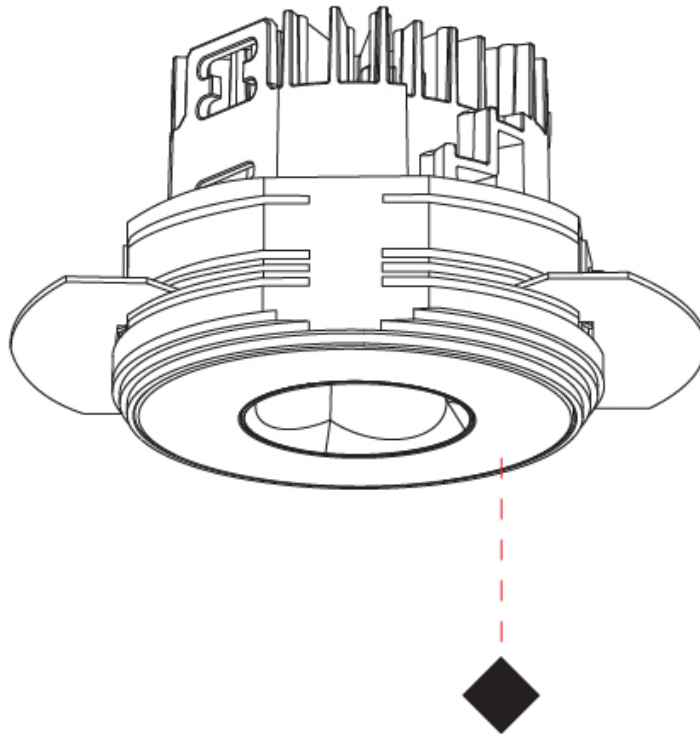

PROJECT
TYPE
SPECIFIER
QUANTITY
DATE

## OIKO PRO ROUND TRIMLESS

### A35879-

base number	Color Temperature	Finishes (Diamond)	Lens Options
-------------	----------------------	-----------------------	-----------------

- To build a product code in our configurator select the specify button on the base model # product page
- To build a manual product code on this datasheet choose from the options listed below in blue font and add the suffix to the base model #

#### GENERAL

Series: Oiko Pro
Subseries: Oiko Pro Round
Brand: Prolicht
Division: Architectural
Mounting Type: Trimless
Mounting Location: Ceiling
Subcategory: Downlight

#### PHYSICAL

Shape: Round
Diameter (mm): 75
Diameter (in): 2 15/16
Height (mm): 51
Height (in): 2
Ceiling Thickness (mm): 10 / 12.5 / 15 / 25
Ceiling Thickness (in): 3/8 or 1/2 or 9/16 or 1
Min. Recessing Depth (mm): 60
Min. Recessing Depth (in): 2 3/8
Light Distribution: Direct
Diffuser: Lens Pack - Spread Lens / Linear Spread Lens / Honeycomb Louver
Fixture Finish: SSR / BKV / CWI / CRY / HAB / UFT / ITA / RUA / FTG / MYG / LOD / PUS / FRO / FUP / KIA / POP / BLS / SPG / MEY / GOH / GUM / CHC / COM / ABZ / JAG / OBR / MOS / ROR
Fixture Material: Aluminum Die Cast
Cut-out Measurements: 68mm / 2 11/16" Diameter

#### ELECTRICAL

Lamp Type: LED (Zhaga Standard)
Input Wattage (W): 15
Total Output Wattage (W): 13.6
Dimming: Tri-Mode (Non-Dimming and Phase Dimming (120Vac only) and 0-10V Dimming)
Driver Included: No
Driver Location: Recessed Housing
Driver Type: Constant Current - Universal
Driver Class: Class 2
Input Voltage (V): 120 - 277
Constant Current (MA): 350

#### LED

Color Temperature (°K): 2700 / 3000 / 3500 / 4000
Max. Delivered Lumen (lm): 1375 / 1462 / 1531 / 1545
Nominal Lumen (lm): 1566 / 1665 / 1743 / 1759
CRI: >90 CRI
Lamp Life (hrs): 50000

#### OPTICAL

Reflector°: 50
Adjustability: Fixed

#### RATINGS AND CERTIFICATIONS

Certified By: Certified for North American Standards
IP rating: IP20

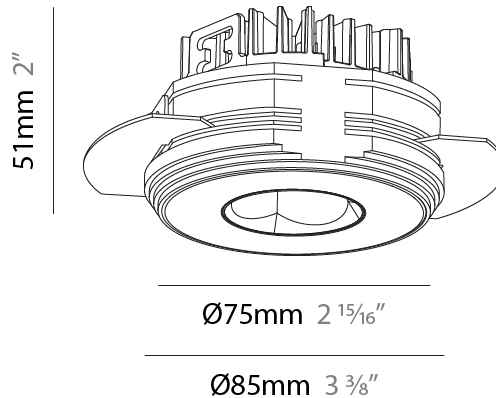

## OIKO PRO ROUND TRIMLESS

A35879-

PROJECT

TYPE

SPECIFIER

QUANTITY

DATE

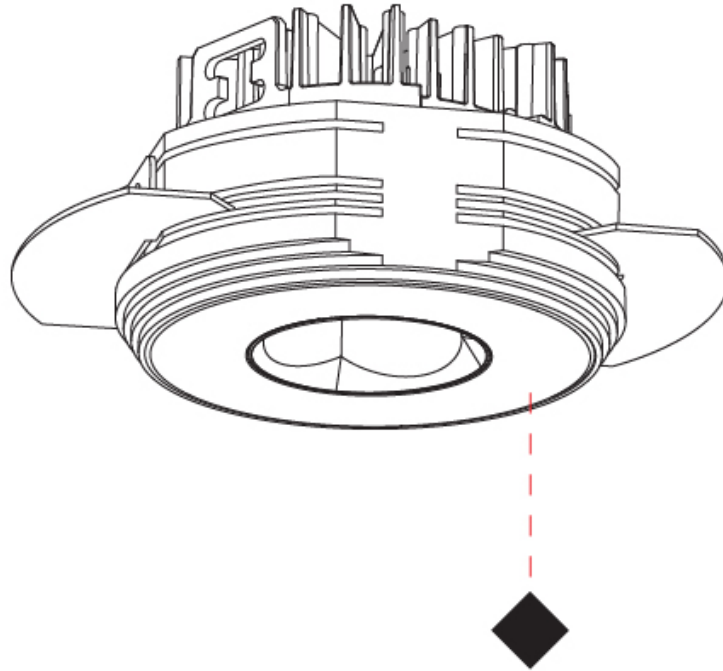

## OIKO PRO ROUND TRIMLESS

**A35880-** \_\_\_\_\_ - \_\_\_\_\_  
 base number Finishes Lens  
 (Diamond) Options

- To build a product code in our configurator select the specify button on the base model # product page
- To build a manual product code on this datasheet choose from the options listed below in blue font and add the suffix to the base model #

### GENERAL

Series: Oiko Pro  
 Subseries: Oiko Pro Round  
 Brand: Prolicht  
 Division: Architectural  
 Mounting Type: Trimless  
 Mounting Location: Ceiling  
 Subcategory: Downlight

### PHYSICAL

Shape: Round  
 Diameter (mm): 75  
 Diameter (in): 2 <sup>15</sup>/<sub>16</sub>  
 Height (mm): 43  
 Height (in): 1 <sup>11</sup>/<sub>16</sub>  
 Ceiling Thickness (mm): 10 / 12.5 / 15 / 25  
 Ceiling Thickness (in): 3/8 or 1/2 or 9/16 or 1  
 Min. Recessing Depth (mm): 50  
 Min. Recessing Depth (in): 1 <sup>15</sup>/<sub>16</sub>  
 Light Distribution: Direct  
 Diffuser: Lens Pack - Spread Lens / Linear Spread Lens / Honeycomb Louver  
 Fixture Finish: SSR / BKV / CWI / CRY / HAB / UFT / ITA / RUA / FTG / MYG / LOD / PUS / FRO / FUP / KIA / POP / BLS / SPG / MEY / GOH / GUM / CHC / COM / ABZ / JAG / OBR / MOS / ROR  
 Fixture Material: Aluminum Die Cast  
 Cut-out Measurements: 86mm / 2 11/16" Diameter

### ELECTRICAL

Lamp Type: LED (Zhaga Standard)  
 Input Wattage (W): 15  
 Total Output Wattage (W): 13.6  
 Dimming: Tri-Mode (Non-Dimming and Phase Dimming (120Vac only) and 0-10V Dimming)  
 Driver Included: No  
 Driver Location: Recessed Housing  
 Driver Type: Constant Current - Universal  
 Driver Class: Class 2  
 Input Voltage (V): 120 - 277  
 Constant Current (MA): 350

### LED

Color Temperature (°K): 2700 / 3000 / 3500 / 4000  
 Max. Delivered Lumen (lm): 1464 / 1556 / 1630 / 1645  
 Nominal Lumen (lm): 1566 / 1665 / 1743 / 1759  
 CRI: >90 CRI  
 Lamp Life (hrs): 50000

### OPTICAL

Reflector°: 60  
 Adjustability: Fixed

### RATINGS AND CERTIFICATIONS

Certified By: Certified for North American Standards  
 IP rating: IP20

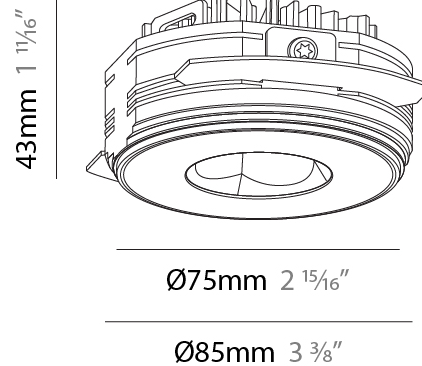

## OIKO PRO ROUND TRIMLESS

A35880-

PROJECT

TYPE

SPECIFIER

QUANTITY

DATE





## OIKO PRO SQUARE FIXED RECESSED

**A35957-** - -

base number    Color    Finishes    Lens  
 Temperature    (Diamond)    Options

- To build a product code in our configurator select the specify button on the base model # product page
- To build a manual product code on this datasheet choose from the options listed below in blue font and add the suffix to the base model #

### GENERAL

Series: Oiko Pro  
 Subseries: Oiko Pro Square Fixed  
 Brand: Prolicht  
 Division: Architectural  
 Mounting Type: Recessed  
 Mounting Location: Ceiling  
 Subcategory: Downlight

### PHYSICAL

Shape: Square  
 Length (mm): 75  
 Length (in): 2 <sup>15</sup>/<sub>16</sub>  
 Width (mm): 75  
 Width (in): 2 <sup>15</sup>/<sub>16</sub>  
 Height (mm): 43  
 Height (in): 1 <sup>11</sup>/<sub>16</sub>  
 Ceiling Thickness (mm): 1 - 25  
 Ceiling Thickness (in): 1/16 - 1 3/16  
 Min. Recessing Depth (mm): 50  
 Min. Recessing Depth (in): 1 <sup>15</sup>/<sub>16</sub>  
 Light Distribution: Downlight  
 Weight (kg): 0.179  
 Diffuser: Lens Pack - No Lens / Opal / Linear Spread Lens / Honeycomb / Spread Lens  
 Fixture Finish: SSR / BKV / CWI / CRY / HAB / UFT / ITA / RUA / FTG / MYG / LOD / PUS / FRO / FUP / KIA / POP / BLS / SPG / MEY / GOH / GUM / CHC / COM / ABZ / JAG / OBR / MOS / ROR  
 Fixture Material: Aluminum Die Cast  
 Cut-out Measurements: D. 68mm / 2 11/16"

### ELECTRICAL

Lamp Type: LED (Zhaga Standard)  
 Input Wattage (W): 15  
 Total Output Wattage (W): 13.6  
 Dimming: Tri-Mode (Non-Dimming and Phase Dimming (120Vac only) and 0-10V Dimming)  
 Driver Included: No  
 Driver Location: Recessed Housing  
 Driver Type: Constant Current - Universal  
 Driver Class: Class 2  
 Input Voltage (V): 120 - 277  
 Constant Current (MA): 350

### LED

Number of LEDs: 1  
 Color Temperature (°K): 2700 / 3000 / 3500 / 4000  
 Max. Delivered Lumen (lm): 1464 / 1556 / 1630 / 1645  
 Nominal Lumen (lm): 1566 / 1665 / 1743 / 1759  
 CRI: >90 CRI  
 Lamp Life (hrs): 50000

### OPTICAL

Reflector°: 50

### RATINGS AND CERTIFICATIONS

Certified By: Certified for North American Standards  
 IP rating: IP20

PROJECT	_____
TYPE	_____
SPECIFIER	_____
QUANTITY	_____
DATE	_____

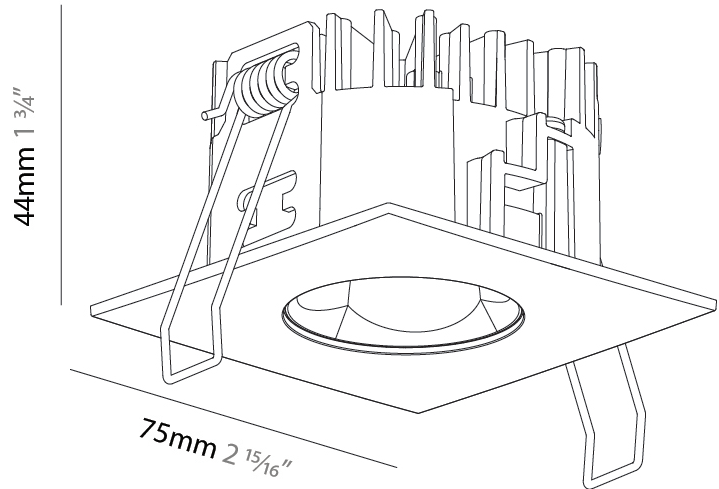

## OIKO PRO SQUARE FIXED RECESSED

A35957-

PROJECT	_____
TYPE	_____
SPECIFIER	_____
QUANTITY	_____
DATE	_____

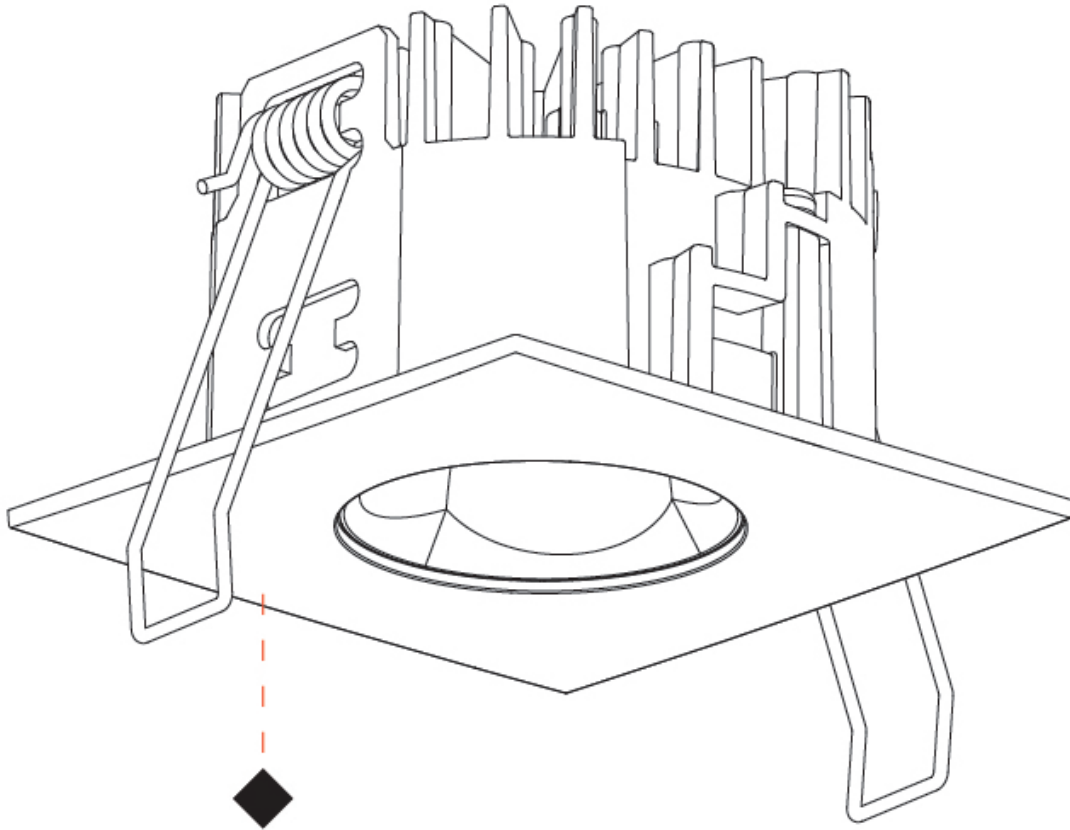

A

PROJECT	_____
TYPE	_____
SPECIFIER	_____
QUANTITY	_____
DATE	_____

## OIKO PRO SQUARE COMFORT RECESSED

### A35973-

base number	Color Temperature	Finishes (Diamond)	Finishes (Triangle)	Lens Options
-------------	----------------------	-----------------------	------------------------	-----------------

- To build a product code in our configurator select the specify button on the base model # product page
- To build a manual product code on this datasheet choose from the options listed below in blue font and add the suffix to the base model #

#### GENERAL

Series: Oiko Pro  
 Subseries: Oiko Pro Square Comfort  
 Brand: Prolicht  
 Division: Architectural  
 Mounting Type: Recessed  
 Mounting Location: Ceiling  
 Subcategory: Downlight

#### PHYSICAL

Shape: Square  
 Length (mm): 92  
 Length (in): 3 5/8  
 Width (mm): 92  
 Width (in): 3 5/8  
 Height (mm): 100  
 Height (in): 3 15/16  
 Ceiling Thickness (mm): 1 - 25  
 Ceiling Thickness (in): 1/16 - 1 3/16  
 Min. Recessing Depth (mm): 110  
 Min. Recessing Depth (in): 4 15/16  
 Light Distribution: Downlight  
 Weight (kg): 0.351  
 Diffuser: Lens Pack - No Lens / Opal / Linear Spread Lens / Honeycomb / Spread Lens  
 Fixture Finish: SSR / BKV / CWI / CRY / HAB / UFT / ITA / RUA / FTG / MYG / LOD / PUS / FRO / FUP / KIA / POP / BLS / SPG / MEY / GOH / GUM / CHC / COM / ABZ / JAG / OBR / MOS / ROR  
 Fixture Material: Aluminum Die Cast  
 Cut-out Measurements: D. 68mm / 2 11/16"

#### ELECTRICAL

Lamp Type: LED (Zhaga Standard)  
 Input Wattage (W): 15  
 Total Output Wattage (W): 13.6  
 Dimming: Tri-Mode (Non-Dimming and Phase Dimming (120Vac only) and 0-10V Dimming)  
 Driver Included: Yes  
 Driver Location: Recessed Housing  
 Driver Type: Constant Current - Universal  
 Driver Class: Class 2  
 Input Voltage (V): 120 - 277  
 Constant Current (MA): 350

#### LED

Number of LEDs: 1  
 Color Temperature (°K): 2700 / 3000 / 3500 / 4000  
 Max. Delivered Lumen (lm): 1424 / 1665 / 1585 / 1599  
 Nominal Lumen (lm): 1566 / 1665 / 1743 / 1759  
 CRI: >90 CRI  
 Lamp Life (hrs): 50000

#### OPTICAL

Reflector°: 58

#### RATINGS AND CERTIFICATIONS

Certified By: Certified for North American Standards  
 IP rating: IP20

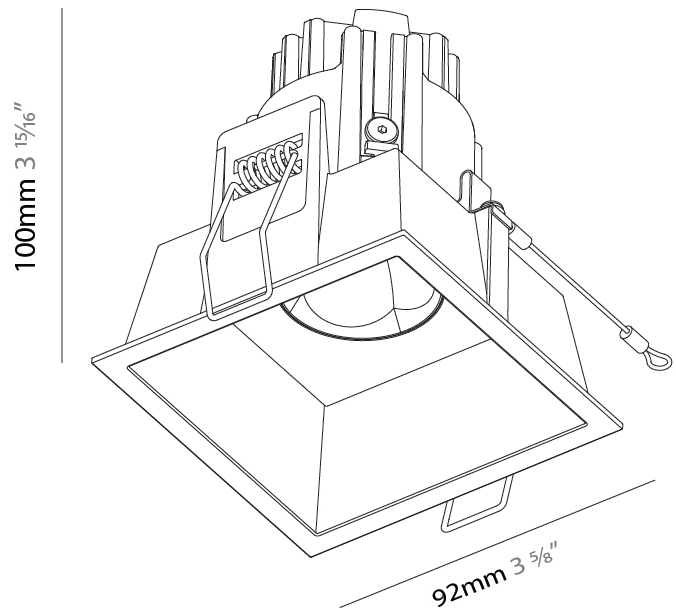
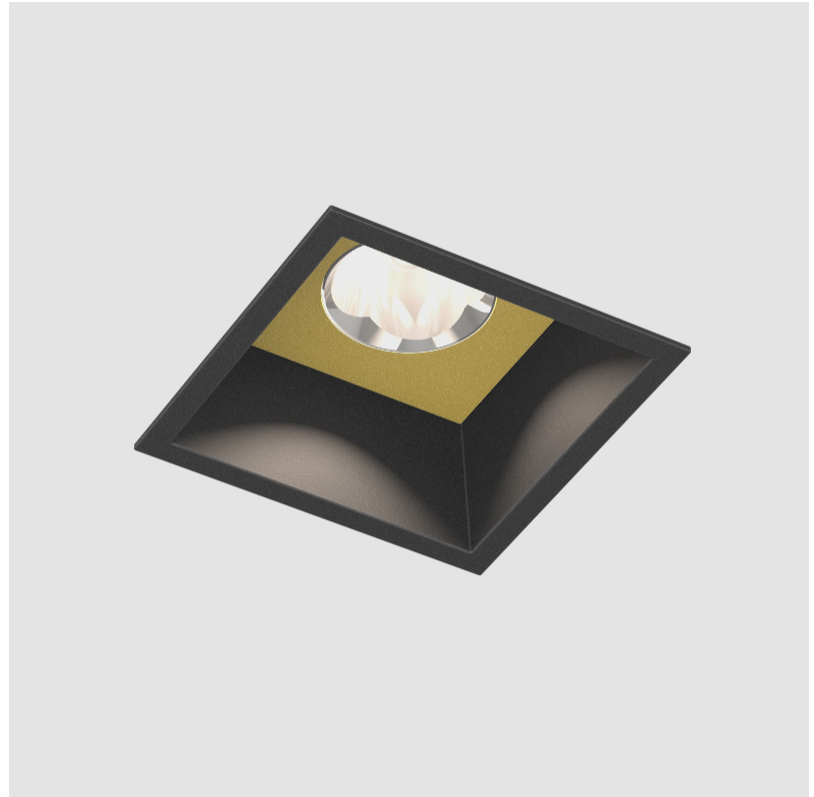

## OIKO PRO SQUARE COMFORT RECESSED

A35973-

PROJECT	_____
TYPE	_____
SPECIFIER	_____
QUANTITY	_____
DATE	_____

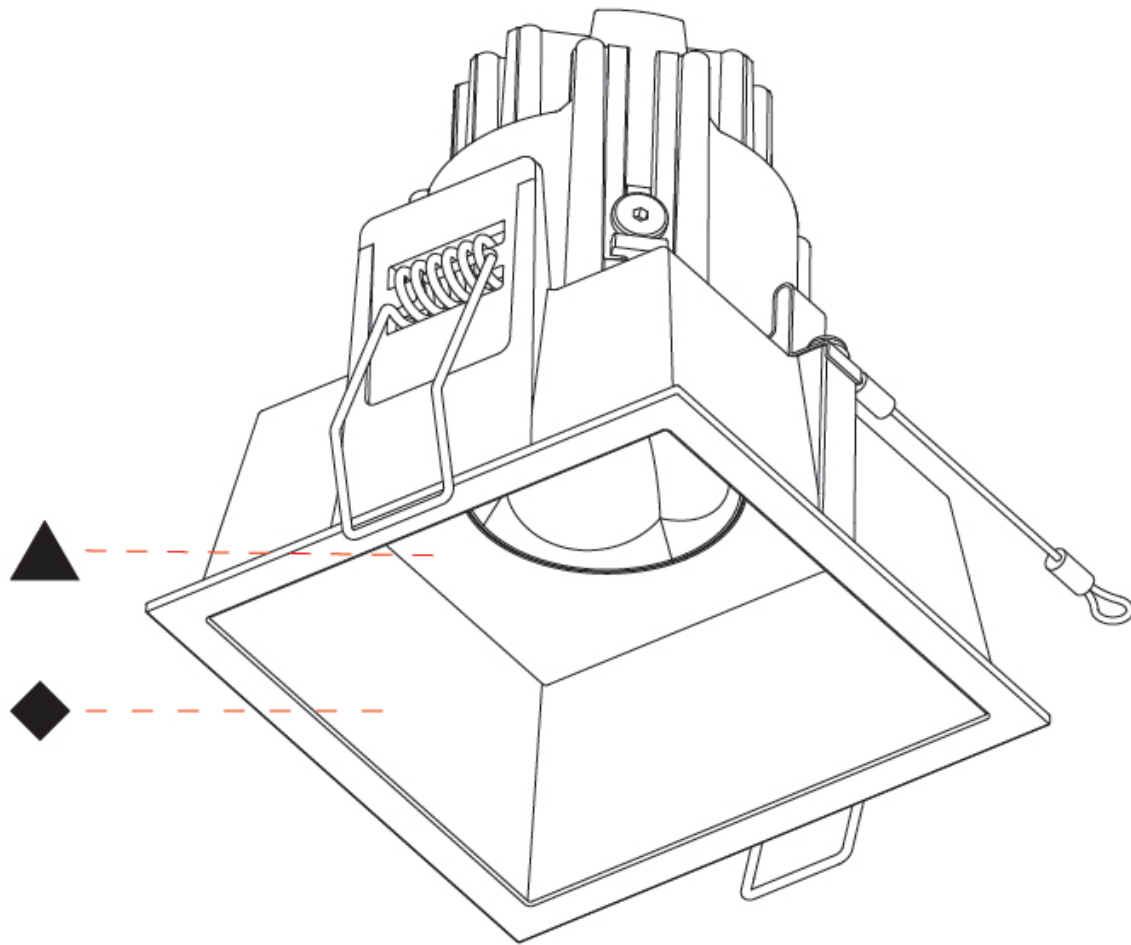

A

## OIKO PRO

### COLOR FINISH CHART

PROJECT \_\_\_\_\_

TYPE \_\_\_\_\_

SPECIFIER \_\_\_\_\_

QUANTITY \_\_\_\_\_

DATE \_\_\_\_\_

#### Fixture Finish

Sparkling Silver - 01 (SSR)



Black Velvet - 02 (BKV)



Crystal White - 03 (CWI)



Creamy - 04 (CRY)



Hampton Bay - 05 (HAB)



Urban Forest - 07 (UFT)



In the Army - 08 (ITA)



Rusty Angel - 09 (RUA)



Fade to Gray - 12 (FTG)



Mysterious Gray - 13 (MYG)



Lost Dream - 15 (LOD)



Purple Sky - 16 (PUS)



Fresh Oh - 17 (FRO)



Funky P. - 18 (FUP)



Kissing Aphrodite - 19 (KIA)



Poseidon's Paradise - 20 (POP)



Blue Sky - 21 (BLS)



Spring Green - 22 (SPG)



Mellow Yellow - 23 (MEY)



Golden Heart - 24 (GOH)



Gun Metal - 25 (GUM)



Champagne Cream - 26 (CHC)



Copper Mine - 27 (COM)



Ancient Bronze - 28 (ABZ)



Jazz Gold - 29 (JAG)



Olive Breeze - 30 (OBR)



Moonlight Silver - 31 (MOS)



Rosewood Red - 32 (ROR)

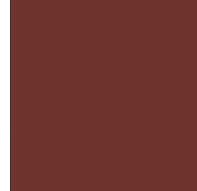

**Digital:** Not all screens are calibrated the same, and therefore, colors will appear differently between screens.





































































**Physical:** When texture is involved, there will be variations in color, character and tone within a product series and between product families.

**Gun Metal:** No Gun Metal finish is alike. It combines a mixture of transparent and black color particles which ensures a highly individual effect and no luminaire being identical.

**Champagne Cream, Copper Mine, Ancient Bronze + Jazz Gold:** These finishes have slight fading from specific powder coating production. Each luminaire will slightly vary.



### LEGEND

 floor-mounted	 pivotable	 special LED (upon request) RGB, RGBW, tunable, gold+, meat+, art+, fashion+
 wall and ceiling: recessed and surface mounted	 rotating	 warm dim / natural dimming LED
 ceiling-mounted and wall-mounted	 illuminate tilted	 rechargeable battery powered
 wall-mounted	 color of suspension cable	 fixture with natural vivid LED (upon request)
 omni-directional light distribution	 length of suspension cable	 color rendering index
 direct light distribution	 reflector degree selection	 color temperature
 direct/indirect light distribution	 super spot	 lumen (luminous flux)
 indirect light distribution	 lens	 efficacy (lumens per watt)
 asymmetric light distribution	 lens pack	 Unified Glare Rating (UGR) range from 5-40
 aura light distribution	 shine ring	 marine grade (AISI 316 stainless steel)
 round wall or ceiling cut-out	 integrated shine ring with diffuser	 walk on
 square wall or ceiling cut-out	 free individual colors 01-29	 drive on
 the supplied jig specifies the cutout dimensions	 individual colors: 00 (free of charge), 01-25 (extra charge)	 Dark Sky Compliance
 minimum distance (meters) lamp - object	 luminaire part to be colored (F1)	 Americans with Disabilities Act (less than 4" off the wall located between 27"-84" from floor)
 recessed depth	 luminaire part to be colored (F2)	 lamp protected against explosion
 ceiling thickness in mm	 luminaire part to be colored (F3)	 blown glass using traditional methods by master glass blower
 ceiling thickness selection	 luminaire part to be colored (F4)	 acoustic material
 dimmable DP (phase), DV (0-10V), DD (dali), DS (step-dim)	 luminaire part to be colored (F5)	 protection class I, protection insulation
 included or excluded LED driver/transformer/control gear	 color of 3-circuit adaptor	 protection class II, protection insulation
 separately switchable	 indirect diffuser	 ETL Certified to UL and CSA Standards
 sensor	 direct diffuser	 UL Certified to UL and CSA Standards
 remote control	 ball-proof (upon request)	 CSA Certified to UL and CSA Standards
 available upon request	 accessory	 Certified for North American Standards

### IP RATING

 IP20	protected against ingress of solid bodies greater than 12.5mm (finger)
 IP33	protected against ingress of solid bodies greater than 2.5mm protected against sprays of water up to 60 degrees from the vertical (rain)
 IP40	protected against ingress of solid bodies greater than 1mm (wire) no protection against the ingress of moisture
 IP43	protected against ingress of solid bodies greater than 1mm (wire) protected against sprays of water up to 60 degrees from the vertical (rain)
 IP44	protected against ingress of solid bodies greater than 1mm (wire) protected against water splashed from all directions
 IP54	protected against limited ingress of dust (wet rooms/covered outdoor areas) protected against water splashed from all directions
 IP65	protected against ingress of dust protected against jets of water
 IP66	protected against ingress of dust protected against powerful jets of water or heavy seas
 IP67	protected against ingress of dust protected against immersion of water between 15cm - 1m for 30 minutes
 IP68	protected against ingress of dust protected against immersion of water under pressure for long periods

### IK RATING

 IK01	protected against 0.14 joules impact (equivalent to 0.25kg mass dropped from 56mm above the surface)
 IK02	protected against 0.2 joules impact (equivalent to 0.25kg mass dropped from 80mm above the surface)
 IK03	protected against 0.35 joules impact (equivalent to 0.25kg mass dropped from 140mm above the surface)
 IK04	protected against 0.5 joules impact (equivalent to 0.25kg mass dropped from 200mm above the surface)
 IK05	protected against 0.7 joules impact (equivalent to 0.25kg mass dropped from 280mm above the surface)
 IK06	protected against 1 joules impact (equivalent to 0.25kg mass dropped from 400mm above the surface)
 IK07	protected against 2 joules impact (equivalent to 0.5kg mass dropped from 400mm above the surface)
 IK08	protected against 5 joules impact (equivalent to 1.7kg mass dropped from 300mm above the surface)
 IK09	protected against 10 joules impact (equivalent to 5.0kg mass dropped from 200mm above the surface)
 IK10	protected against 20 joules impact (equivalent to 5.0kg mass dropped from 400mm above the surface)